



DIEHL
Metal Applications

**PLATING
TECHNOLOGY**



ONE OF THE WORLD LEADING GALVANIC PLATING SPECIALISTS

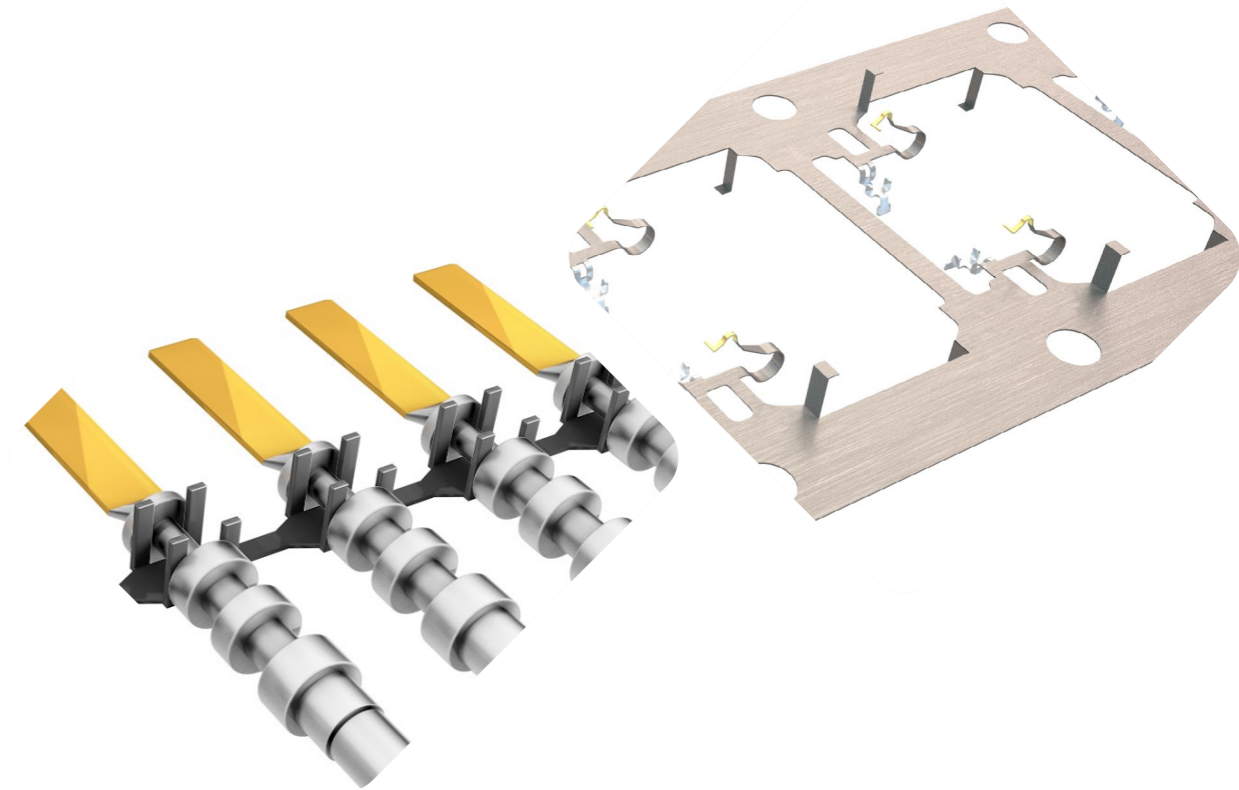

With a broad spectrum of high-tech electroplating processes, Diehl Metal Applications offers customized, state-of-the-art solutions.

New materials and increasingly sophisticated applications place stringent demands on the plated surface. No matter whether it is wear strength, solderability, corrosion resistance or conductivity that is required, our surface finishes ensure reliability and a long product service life.

Using established selective processes as well as successfully patented special processes, we provide either full-surface plating or partial plating of stamping grids and semi-finished products made of various metals, depending on your requirements.

By continually monitoring quality during and following the plating process, we guarantee surface finishing to the highest standard.

We continually develop new, innovative processes in reel-to-reel plating, such as the plating of aluminum strip material. With our highly selective plating technologies – like our patented system for the internal plating of closed pre-bent contact springs – we achieve maximum selectivity and minimum precious metal consumption.



OUR KNOW-HOW AND SERVICE

Electroplating with:

- DMA Advanced Indium
- DMA Advanced SilverTin
- Gold
- Bondable gold / Silver
- Bondable nickel / Nickel-phosphorus
- Copper
- Nickel
- Nickel-phosphorus
- Palladium-nickel
- Silver
- Tin
- Tin / Lead

Electroplating of:

- Bronze
- Brass
- Copper
- Aluminum (reel-to-reel and single-piece)
- Steel
- Stainless steel

STANDARD TECHNIQUES

In many cases, surface plating solves the conflict of interests between the technological demands placed on the base material and the operating conditions.

With our standard plating technologies, we provide our customers with a broad spectrum of established selective processes for plating stamping grids and semi-finished products.

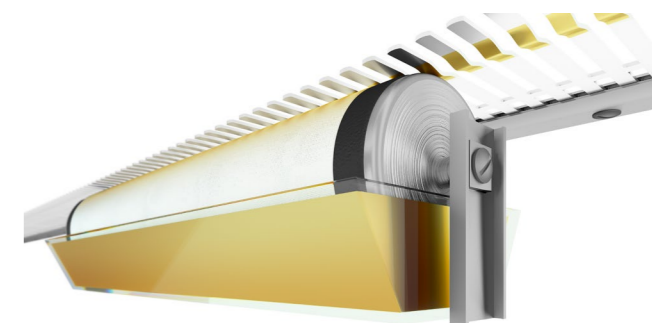

Brush Plating

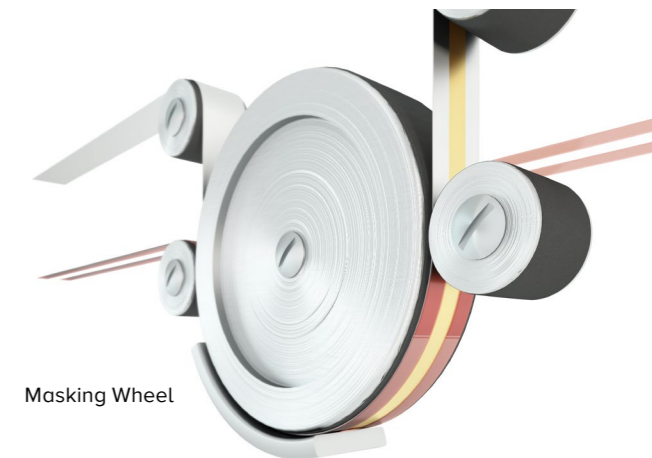

Masking Wheel

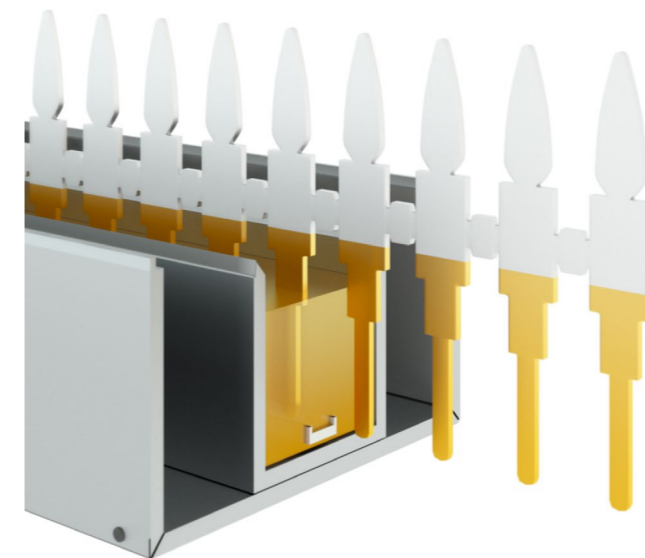

Immersion Plating

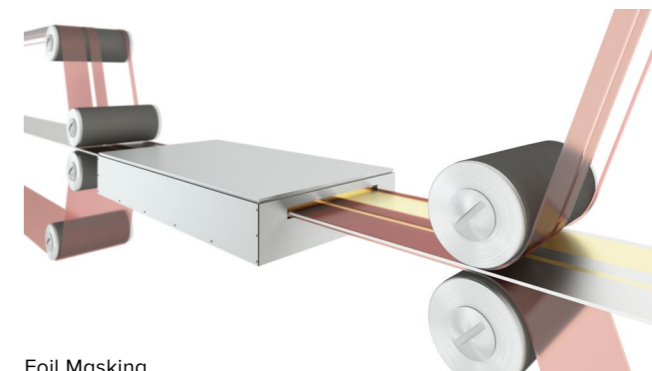

Foil Masking

HIGHLY SELECTIVE TECHNIQUES

With our processes for plating highly complex stamping strip and semi-finished products, we are setting new standards in reel-to-reel plating. Our highly selective plating technologies enable economic use of precious metals – just as our customers require.

Our know-how:

- Internal Plating
- Mechanical Spot Plating (MLP)
- Variable Spot Plating (MLP and MP)

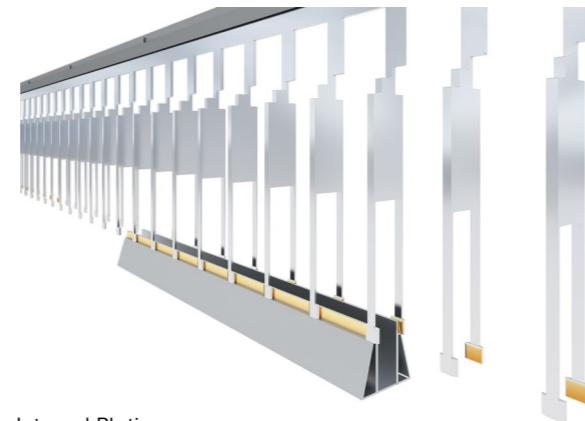

Internal Plating

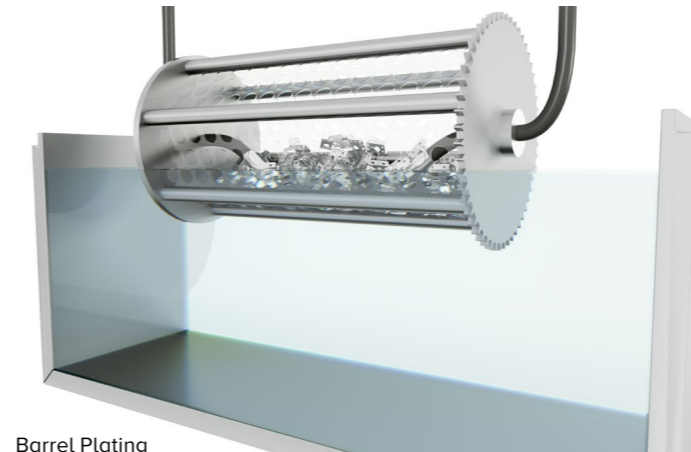

Barrel Plating

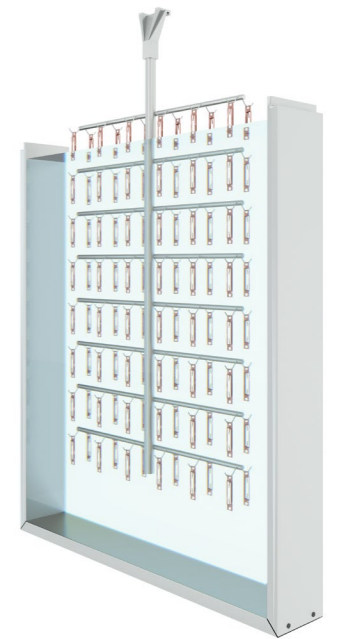

Rack Plating

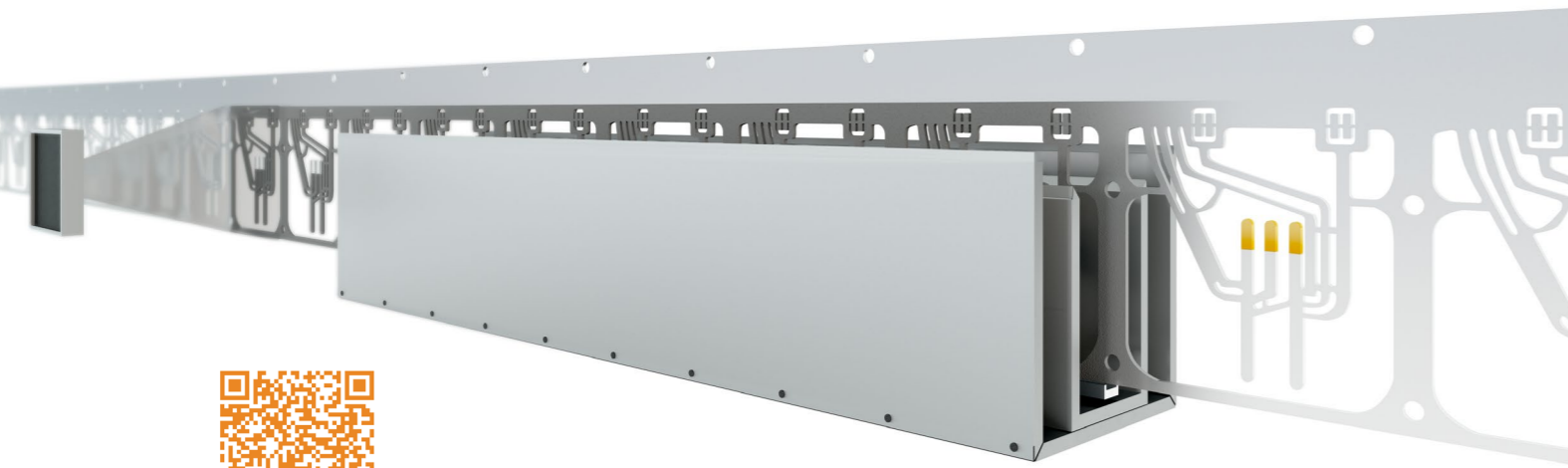

Variable Spot Plating



Animations at
www.diehl.com/metall

SPECIAL TECHNIQUES

With the development of special technologies in reel-to-reel plating, such as the use of tin-free surfaces for press-fit zones, we provide our customers with fresh impetus during product development:

- DMA Advanced Indium
DMA Advanced SilverTin
- Aluminum Strip Plating (ASP made by Diehl)
- Palladium-nickel as a gold replacement
- Electropolishing | Tin Reflow
- Bondable surfaces on the basis of silver, gold, nickel and nickel-phosphorus

SINGLE PARTS

Our customers profit from cutting-edge plating technologies, ranging from small batches to fully automated rack-and-barrel processing:

- Process flexibility
- Customized solutions
- Production according to individual requirements
- Technology concepts and development
- Prototype production
- Pilot production, small batches
- Special processes

Your Contact Partners:

Sales Office Berlin

Phone +49 30 84784-438

E-mail: sales-berlin@diehl.com

Sales Office Vienna

Phone +43 1 7150960-10

E-mail: sales-wien@diehl.com

Sales Office Siaugues

Phone +33 4 7174-0937

E-mail: sales-siaugues@diehl.com

Sales Office Wuxi

Phone +86 510 8269-1270

E-mail: dec-sales@diehl.com

www.diehl.com/metal